

# Dot to Dot

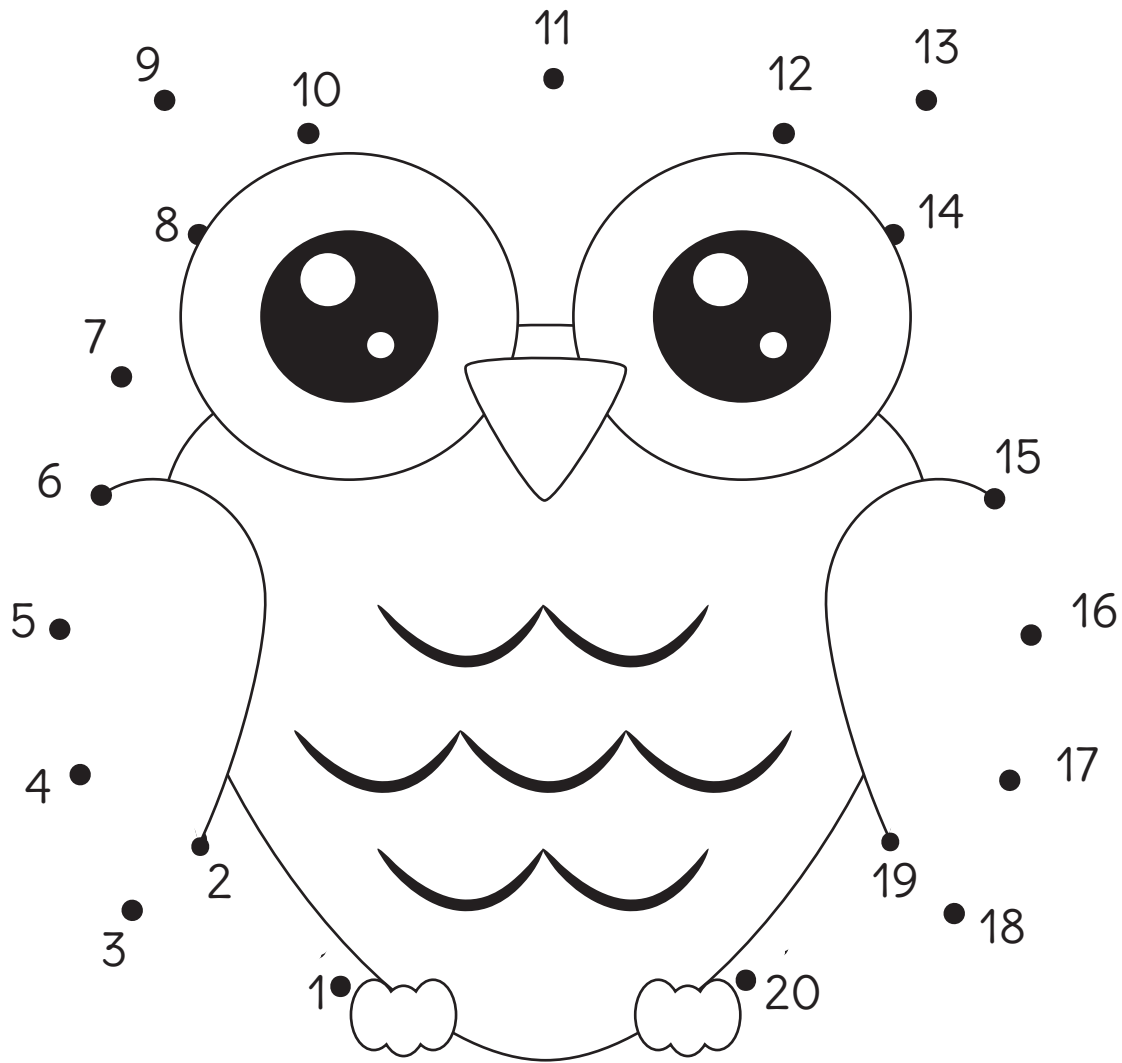

# Dot to Dot

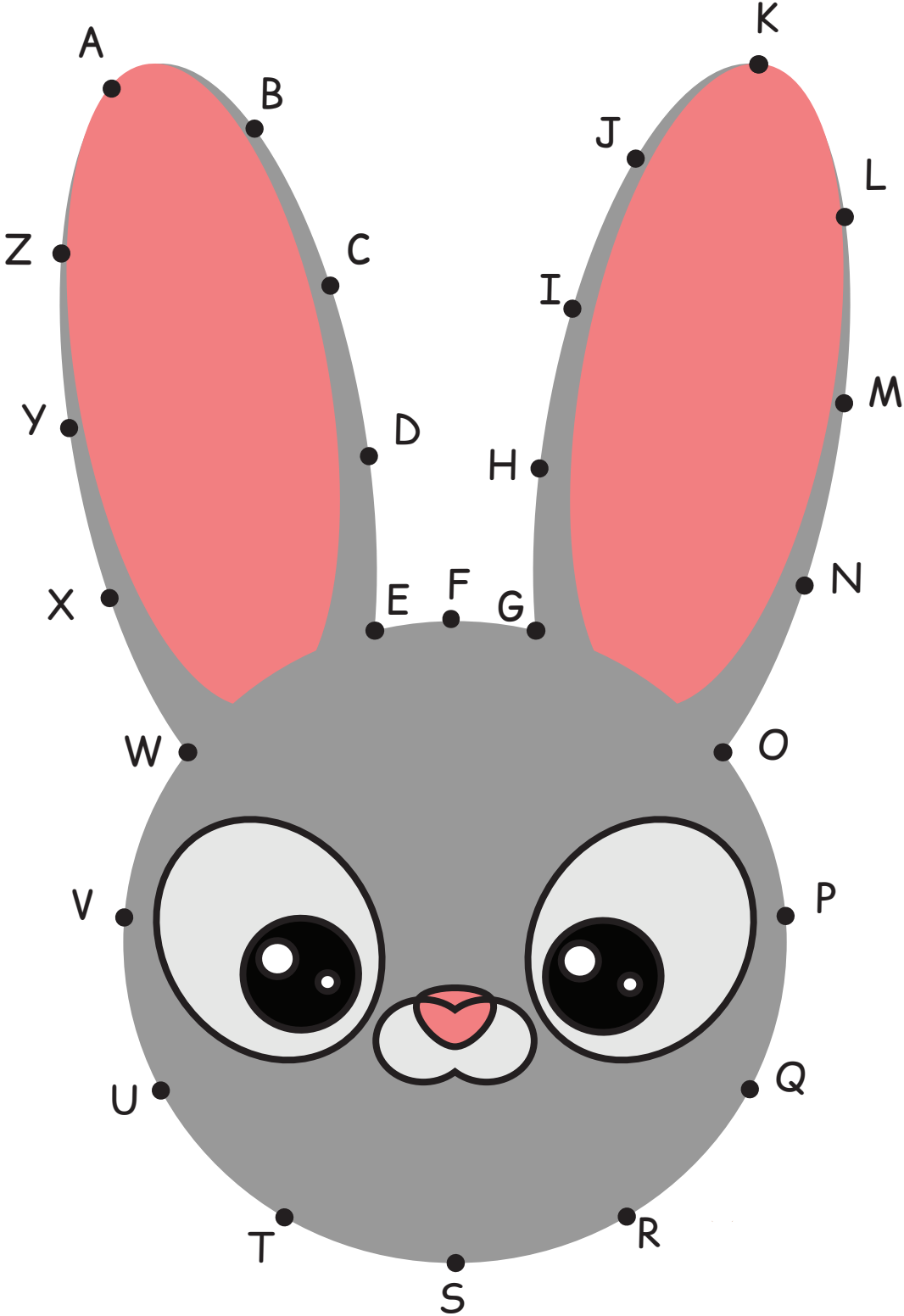

# Dot to Dot

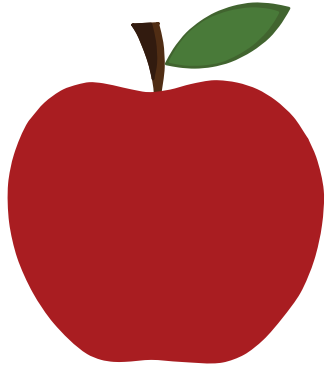
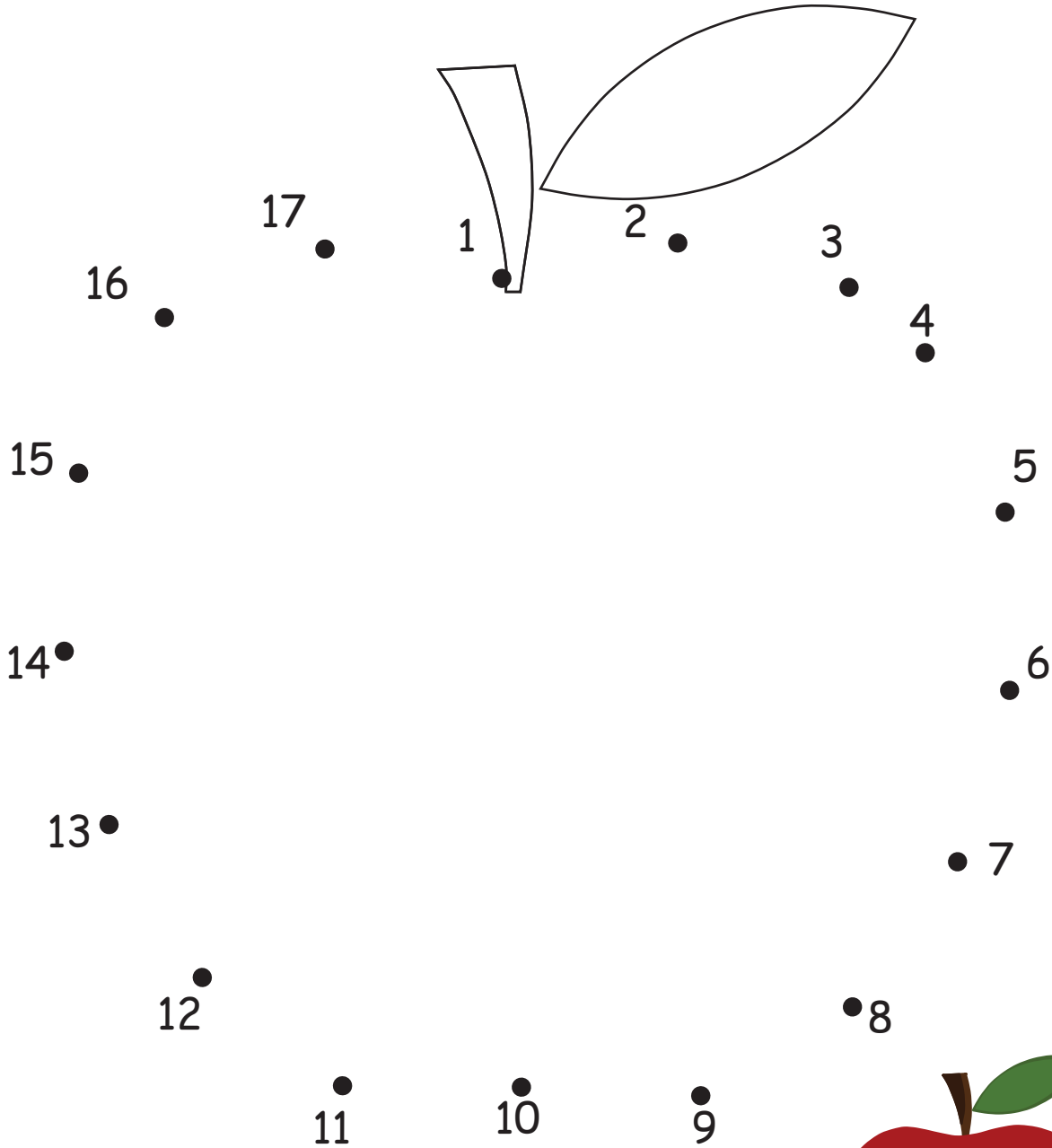

# Dot to Dot

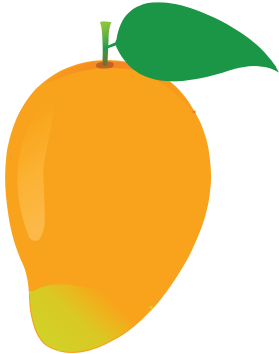
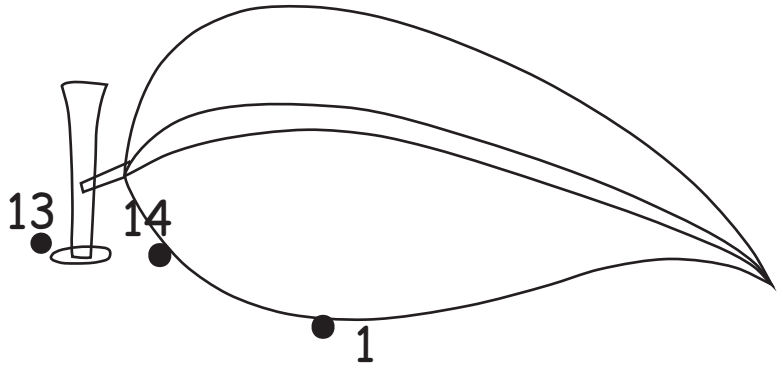

# Dot to Dot

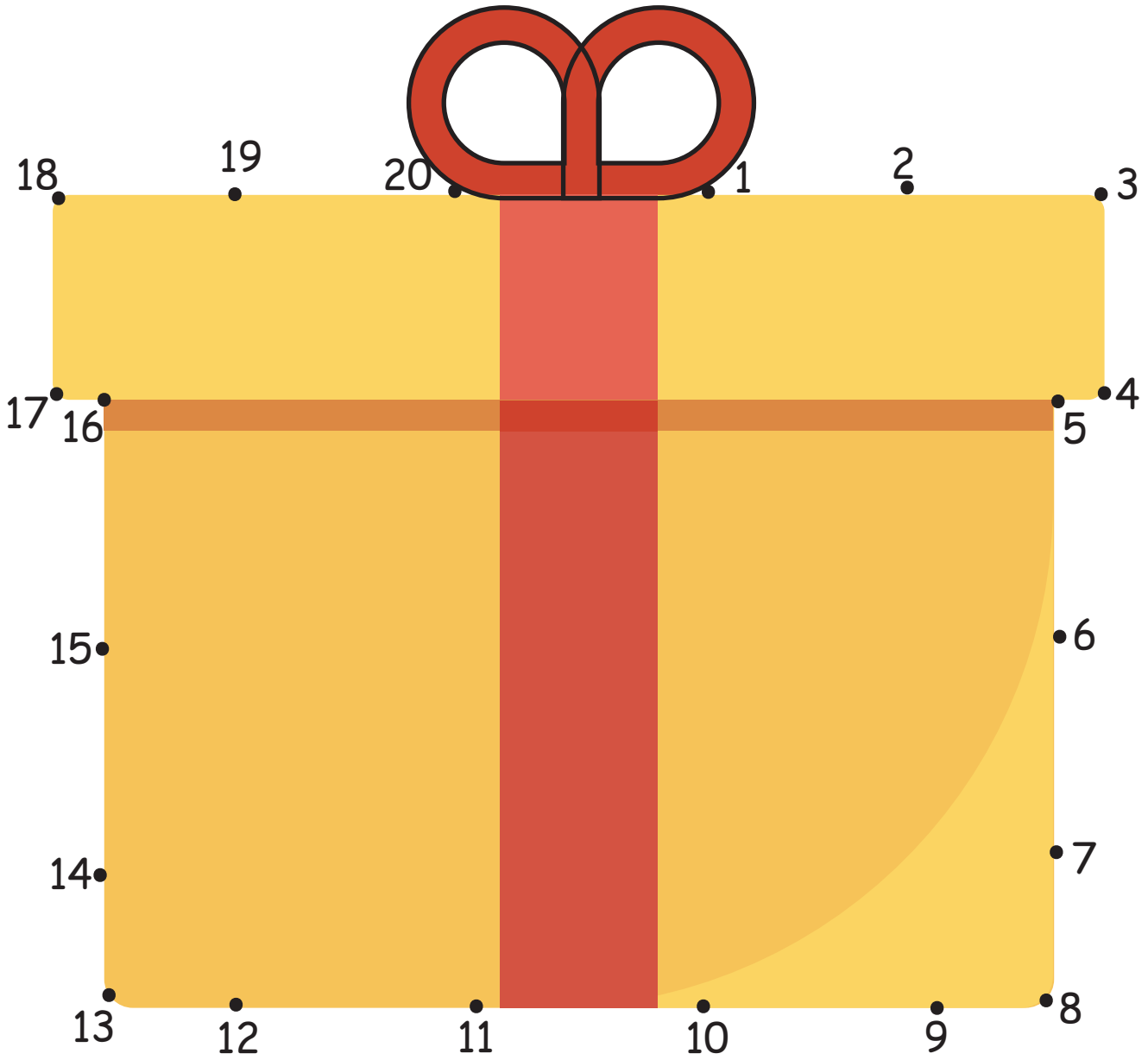

# Dot to Dot

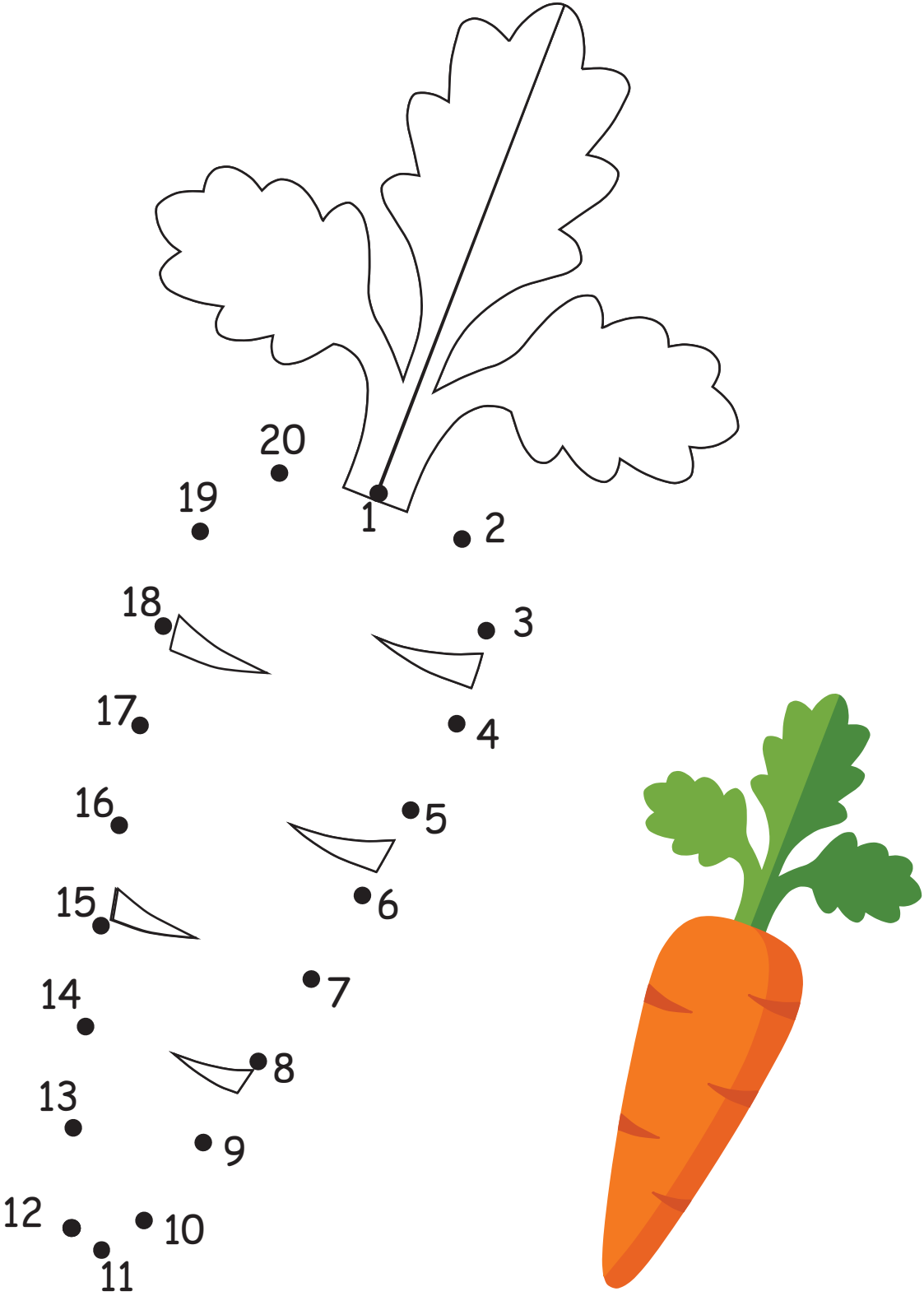

# Dot to Dot

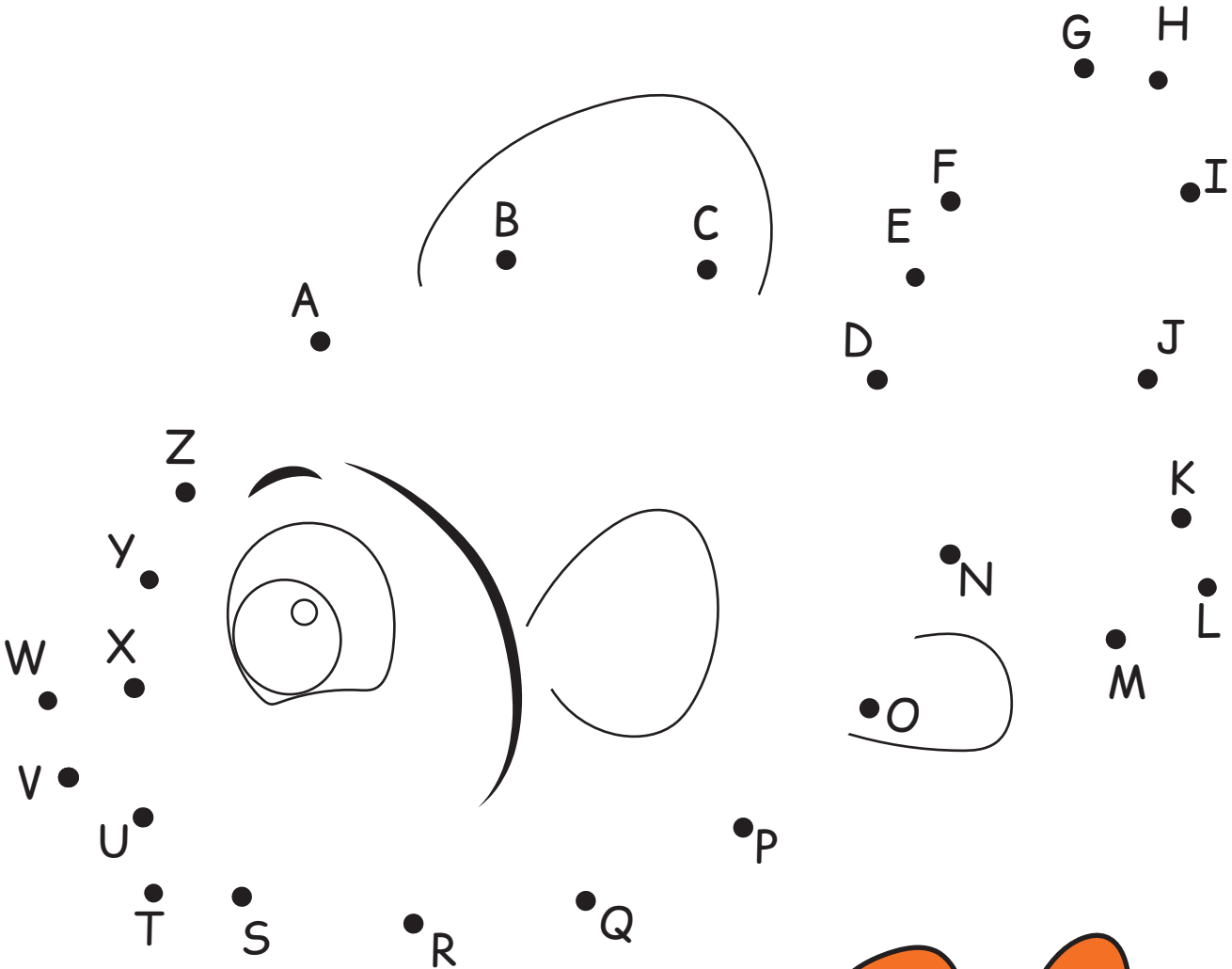

# Dot to Dot

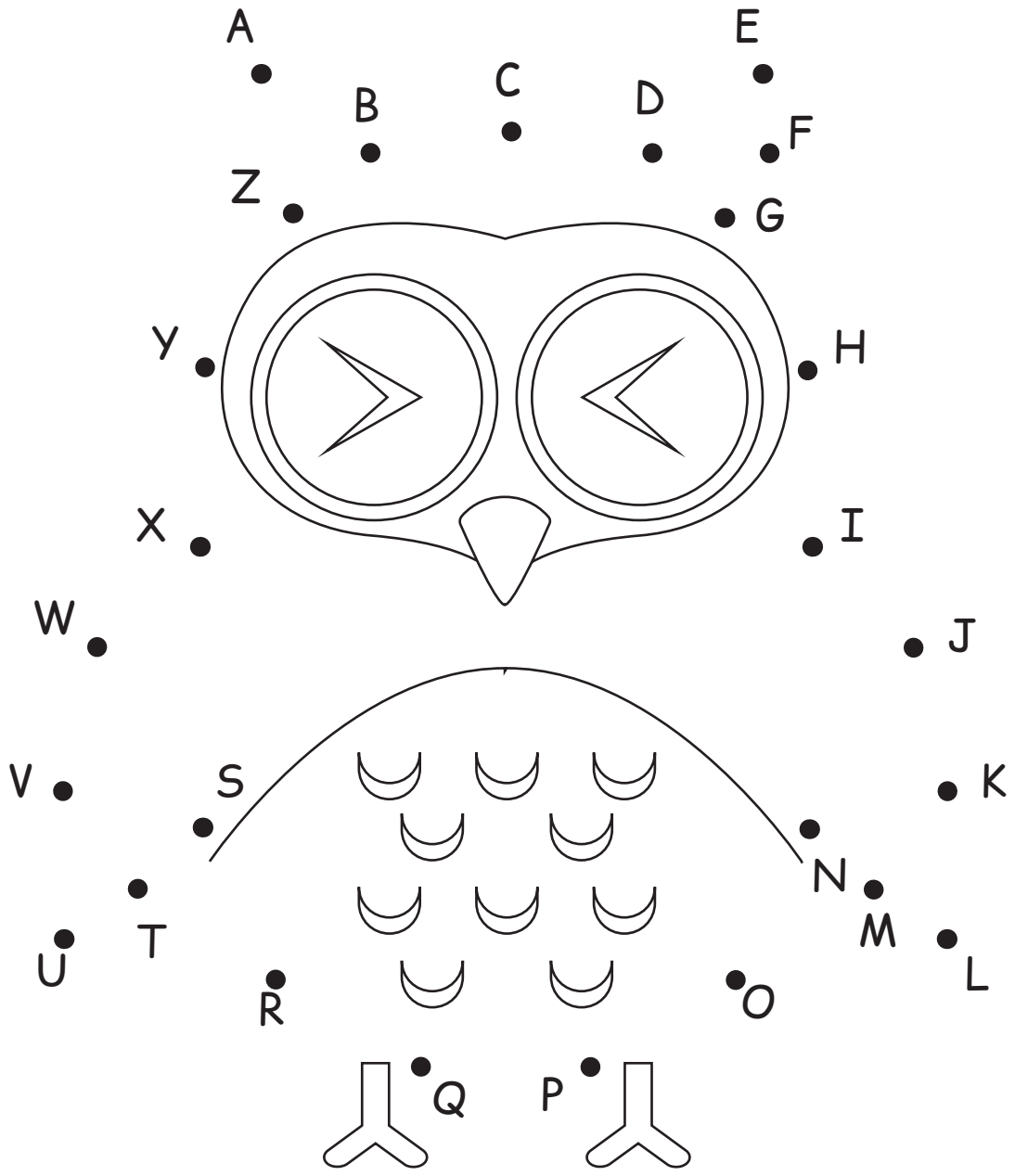



# Dot to Dot

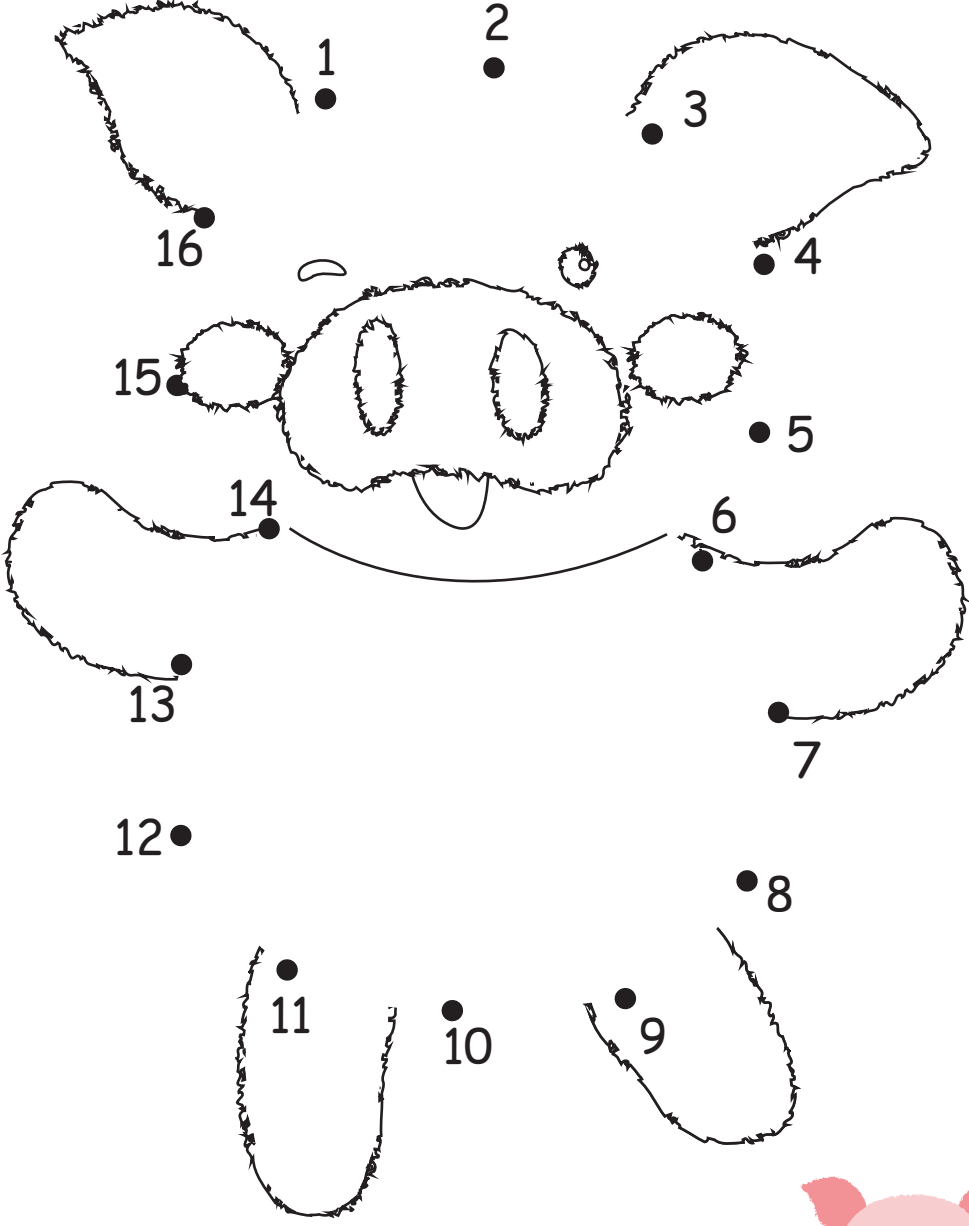

# Dot to Dot

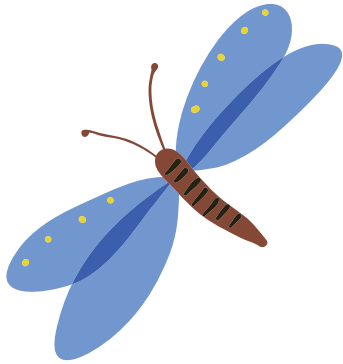
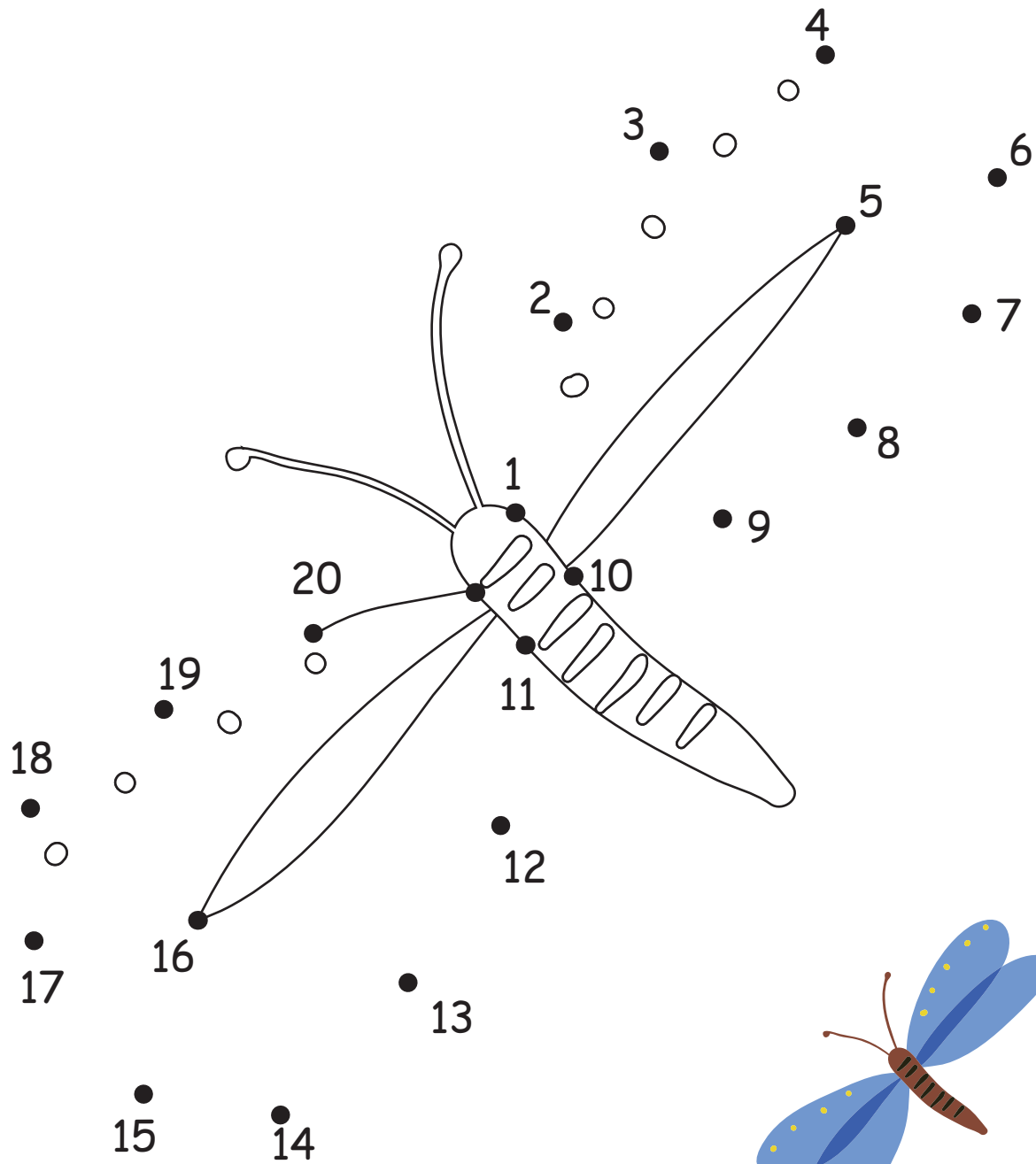

# Dot to Dot

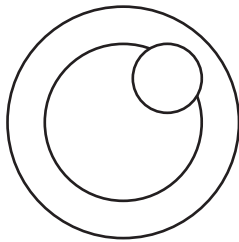
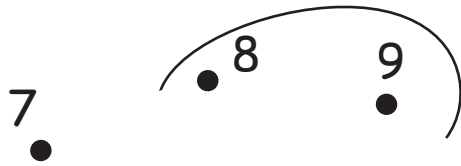
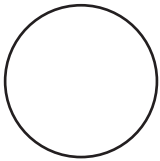
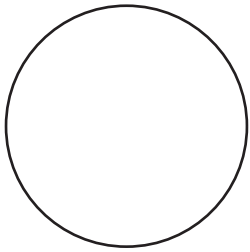

5

6

4

3

2

1

10

11

12

13

14

15

16

19

18

17

20

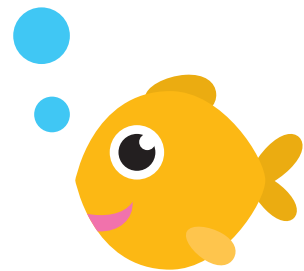

# Dot to Dot

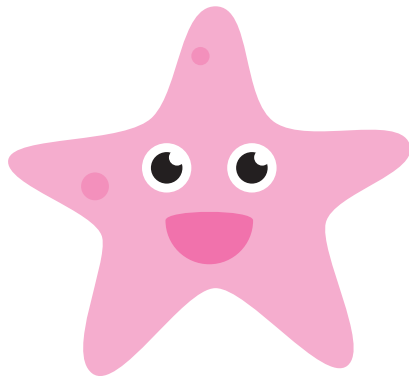
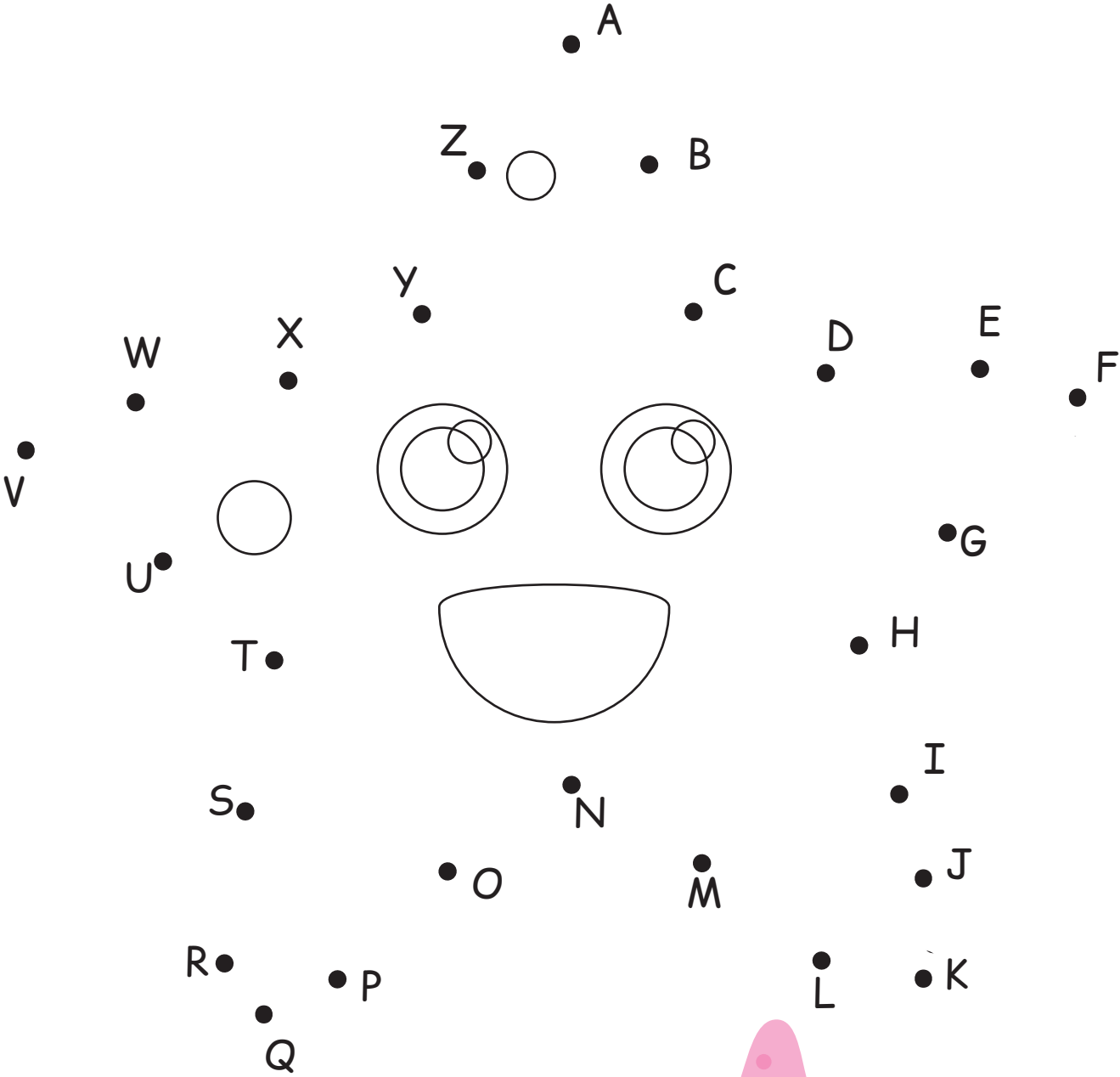

# Dot to Dot

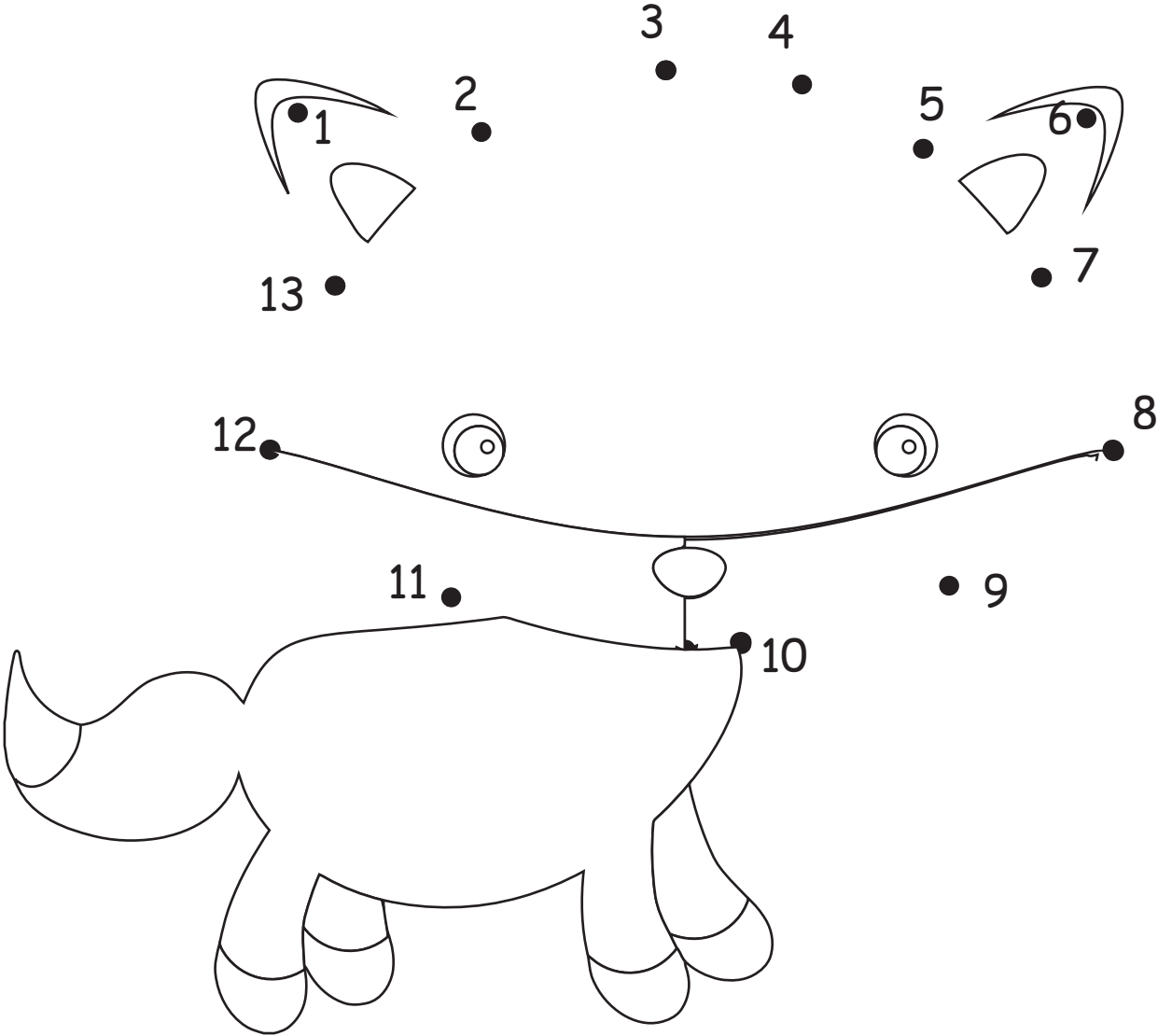

# Dot to Dot

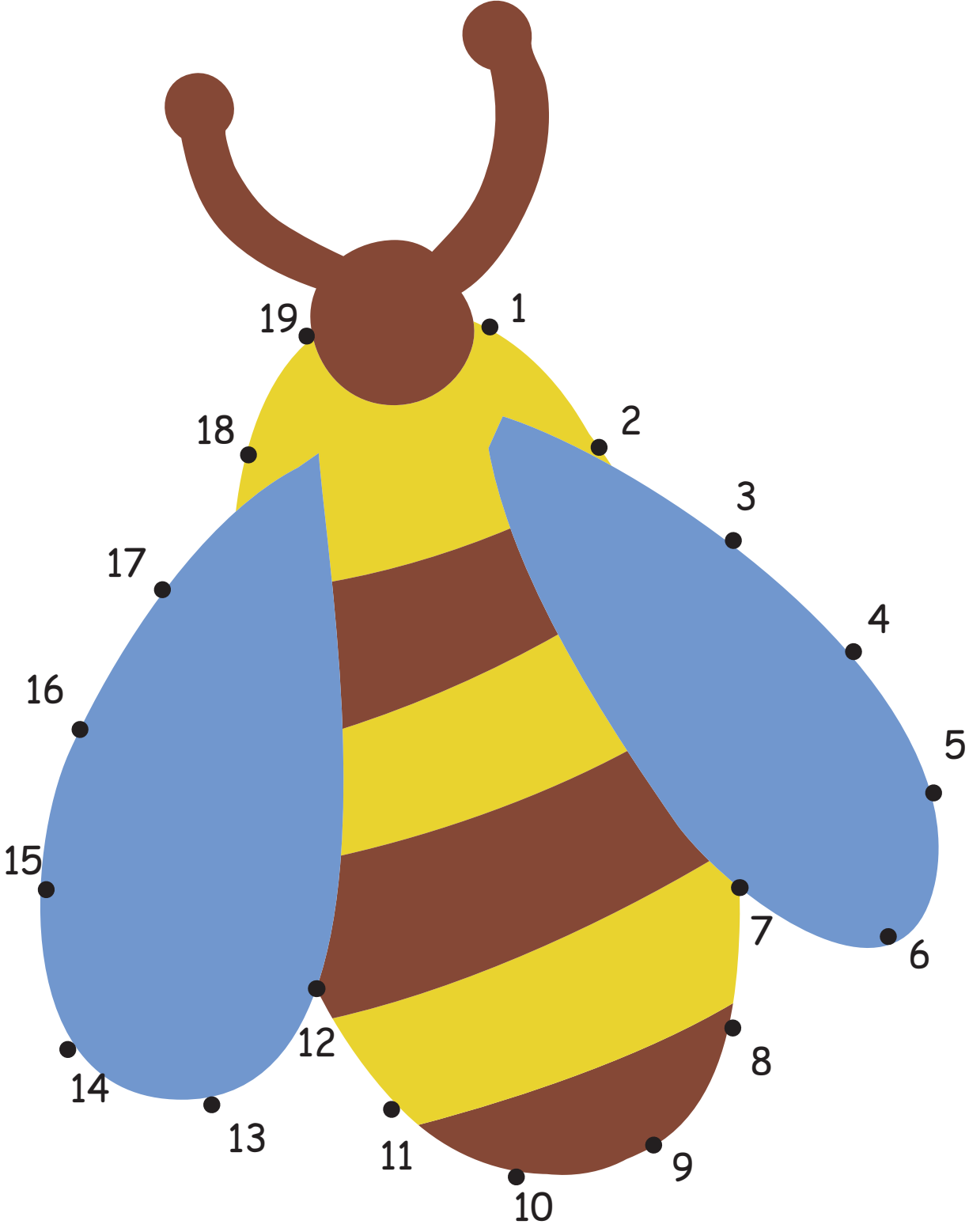

# Dot to Dot

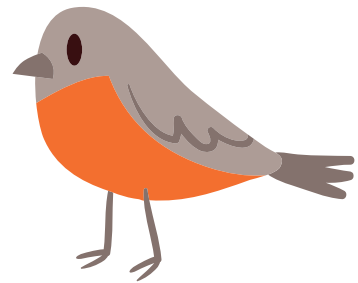
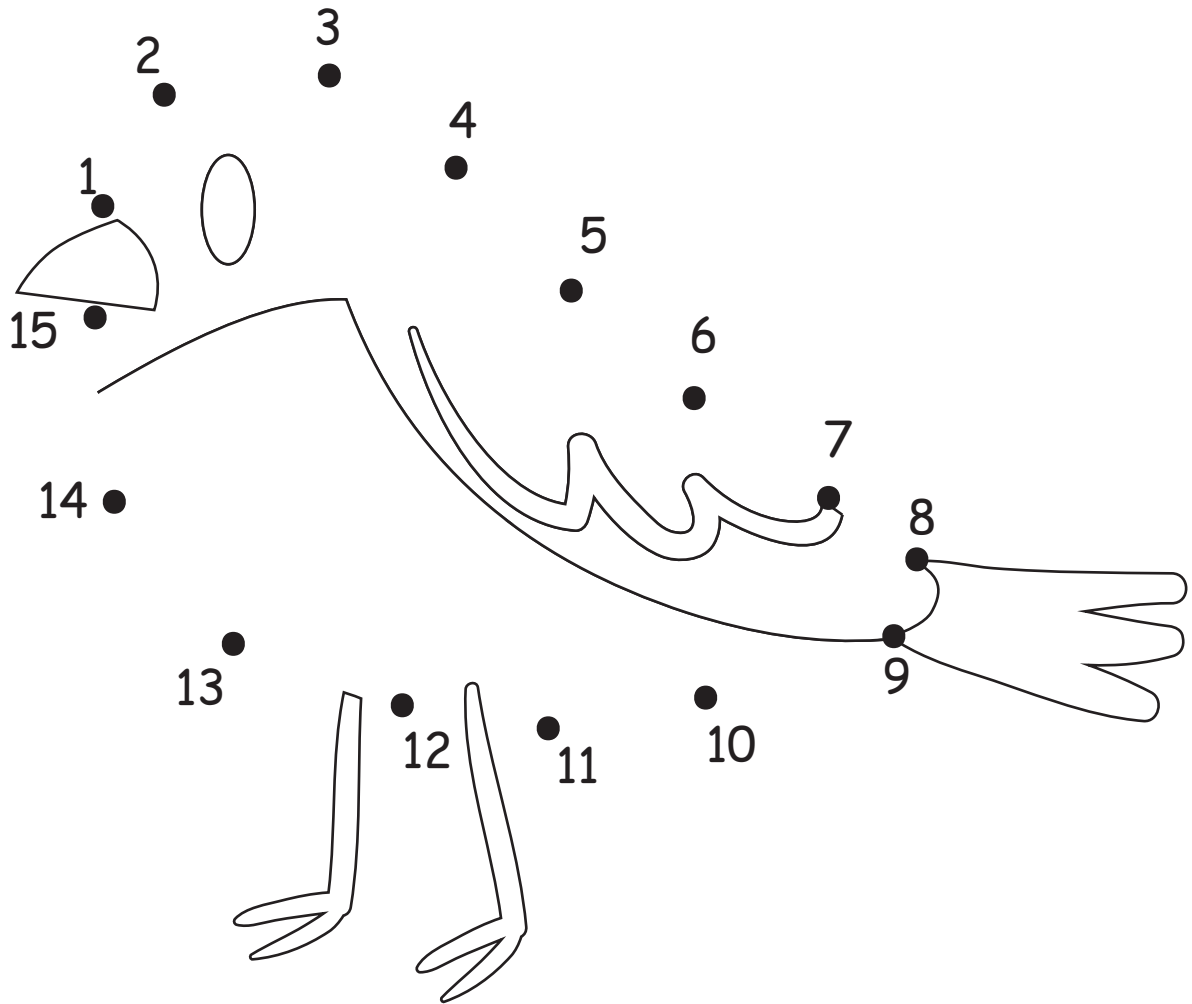

# Dot to Dot

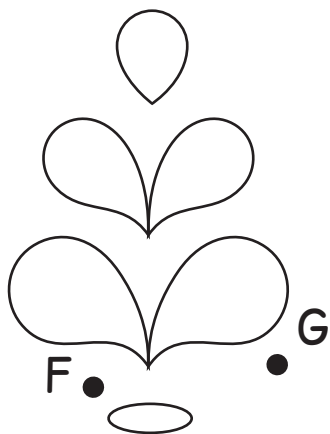

E.

I.

D.

O P Q R S  
J N M U T

C.

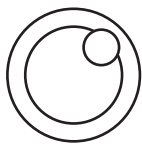

K L

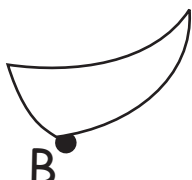

B.

V

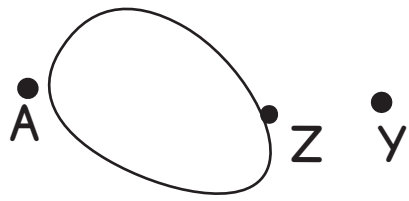

A.

X

W

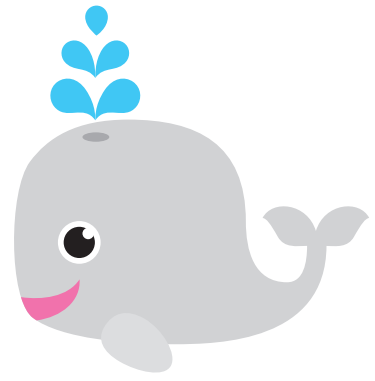



# Dot to Dot

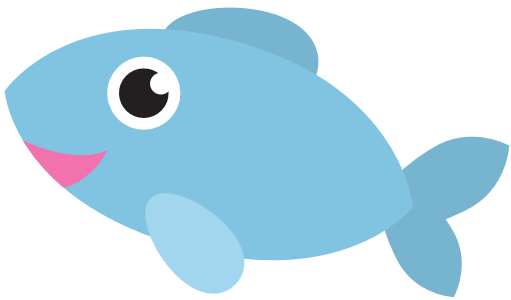
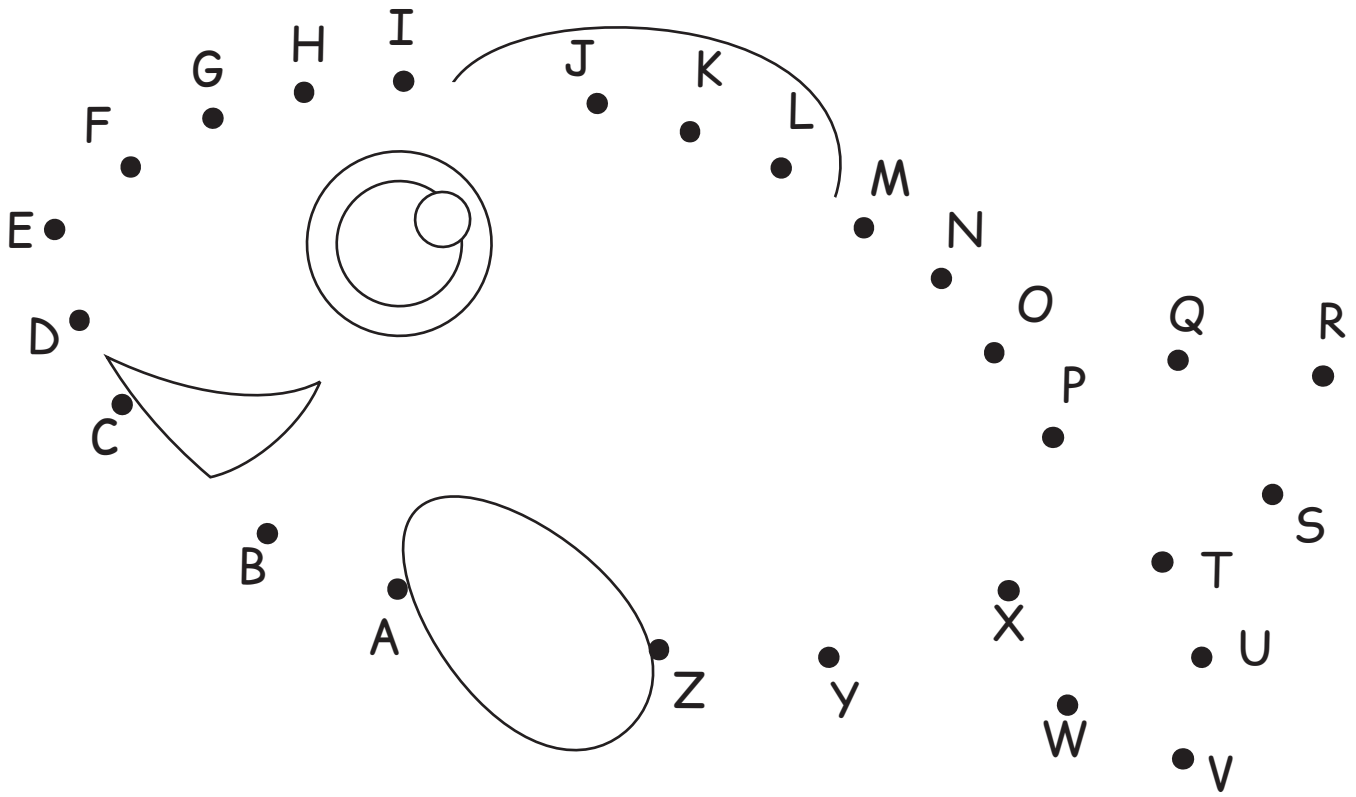

# Dot to Dot

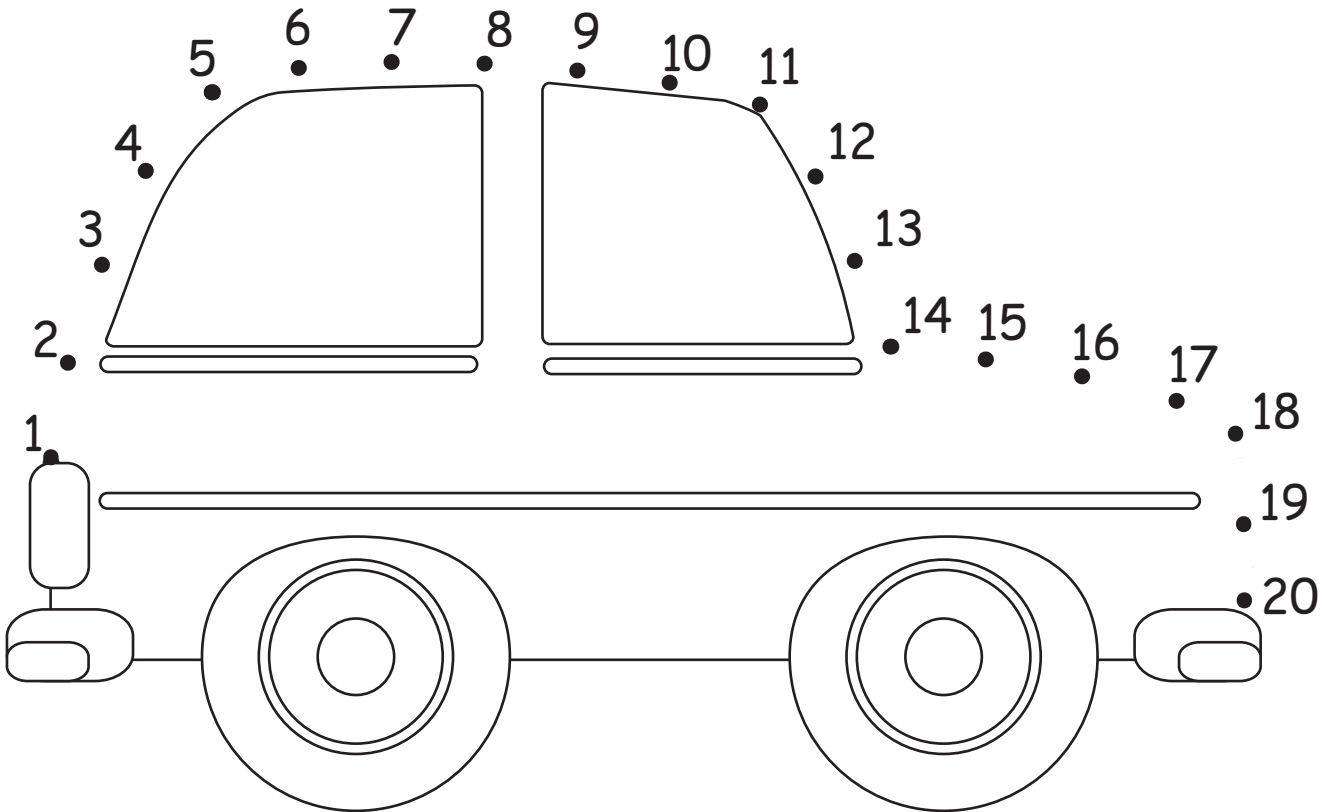

# Dot to Dot

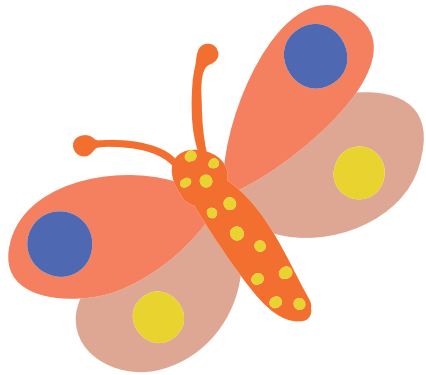
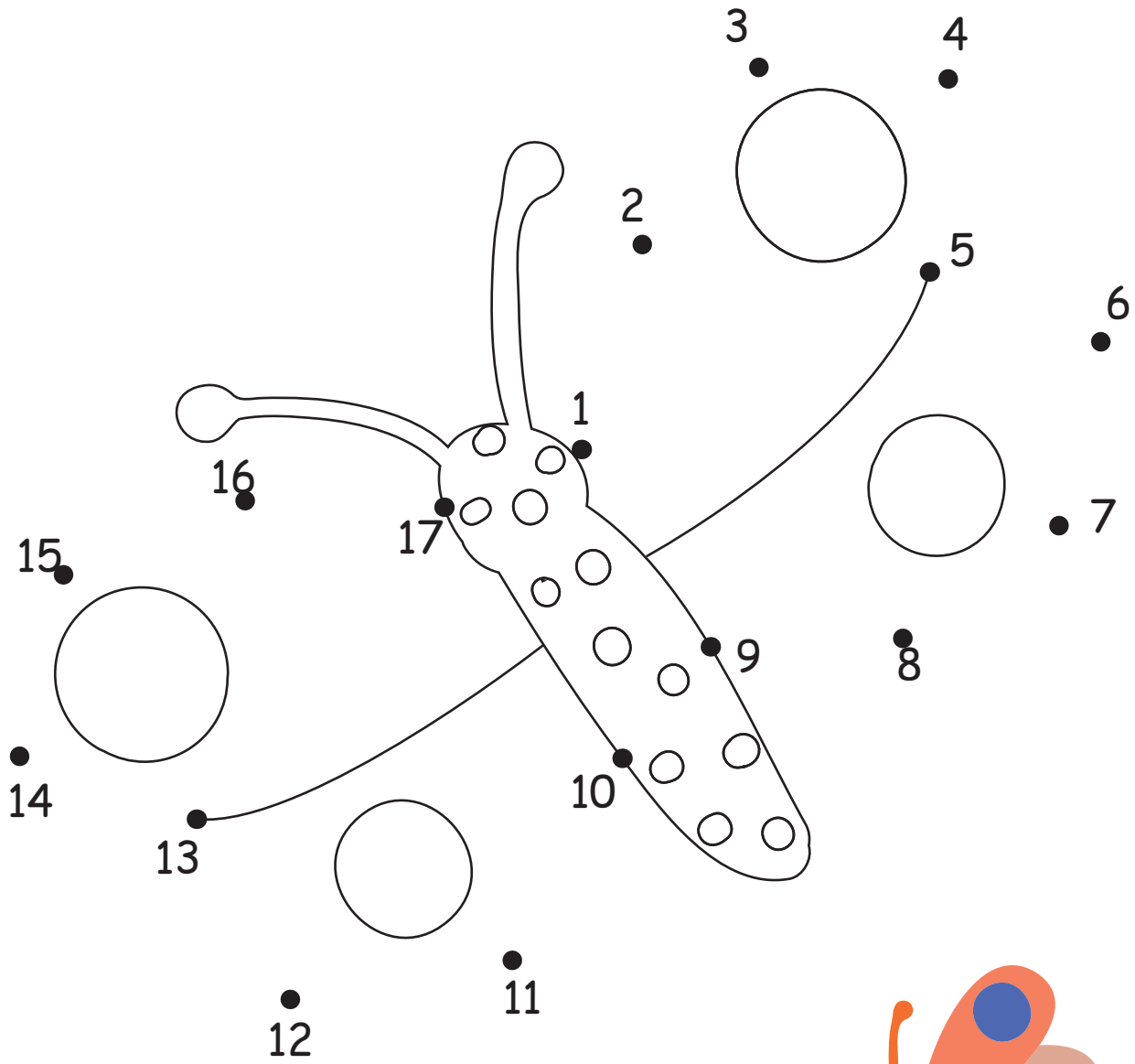

# Dot to Dot

